

GET-B40Zf

Outdoor

GET•LED®

B series



Product Dimension

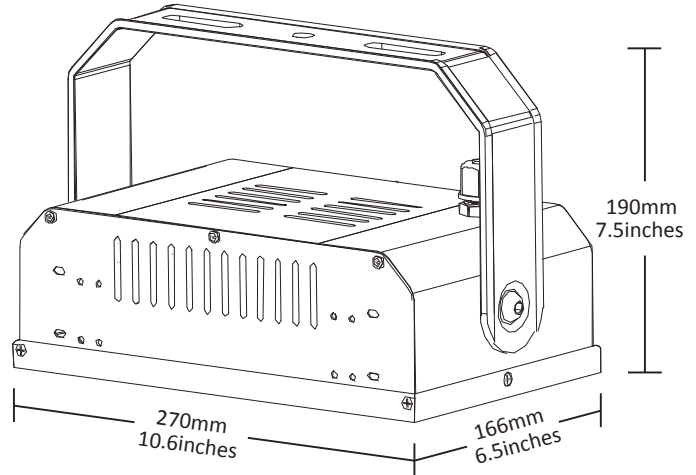

LED Flood Light

Reemplazo de 70W HID



Driver LED de alta gama

PHILIPS

LUMILEDS Fuente luminosa LED de alta calidad



CE ROHS CB

Orgullosos de su alta potencia LED en luminarias **ONE 4 ALL** presenta esta nueva serie de productos de ahorro de energía a base de LEDs de alta potencia como fuente de iluminación que supera a la iluminación tradicional.

- **GET•LED Serie B** es una luminaria LED compuesta de una estructura de aluminio con un cristal templado transparente, materiales de primera calidad, que proporciona una apariencia elegante donde se coloque.
- Proporciona una iluminación uniforme, con un amplio rango, sin generar sombras.
- Iluminación perfecta en un amplio rango de distancia.
- Ideal para cualquier proyecto de iluminación arquitectónica; paredes de hoteles o centros comerciales, espacios abiertos, espectaculares, jardines, interiorismo, etc...
- Buena disipación del calor emitido gracias a un diseño tecnológico innovador, con cuerpo de aluminio.
- Amplio rango de voltaje de entrada.
- Proyección del haz de luz a gran distancia con toda la luminosidad, eficiencia y ahorro del **GET•LED**

Saving with LED power, GET•LED B series lights use an aluminum frame with a tempered glass that provides a stylish look where it is placed. The light has a good heat dissipation delivered through innovative technological design, fixture with aluminum body.

Features:

- Wide range of input voltage.
- Light beam projection at a great distance with the LED power of brightness, efficiency and saving.
- Perfect illumination at a wide range.
- Ideal for any architectural lighting project; hotels walls or shopping centers, open spaces, gardens, billboards, also indoor projects.
- Good heat dissipation delivered through innovative technological design, fixture with aluminum body.



LUXEON T

High-Efficacy, Illumination Grade LED light source.

LUXEON®
NEVER BEFORE POSSIBLE



Isolux diagram

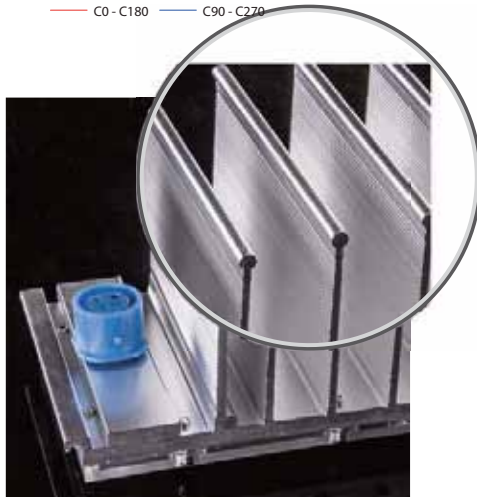
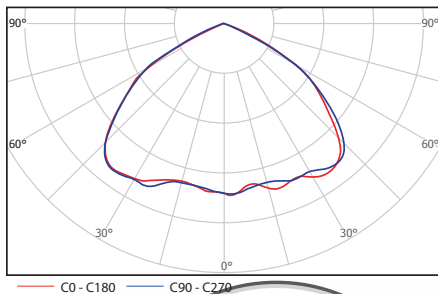
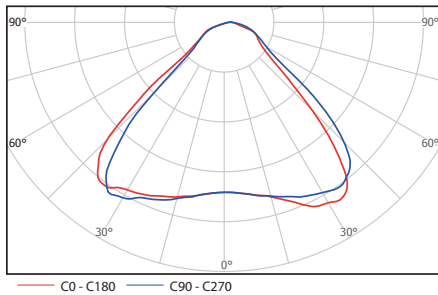
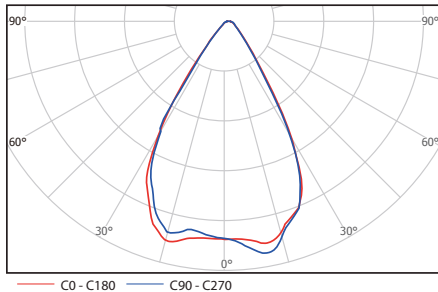

Filos redondeados para evitar cortes al manipularlo

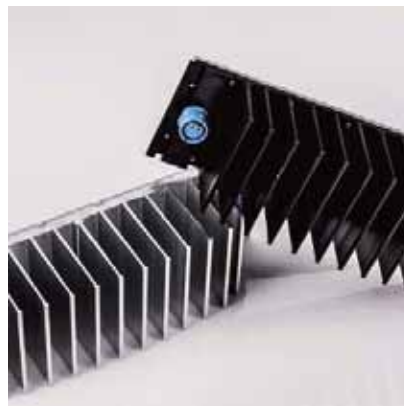

En color negro o plateado

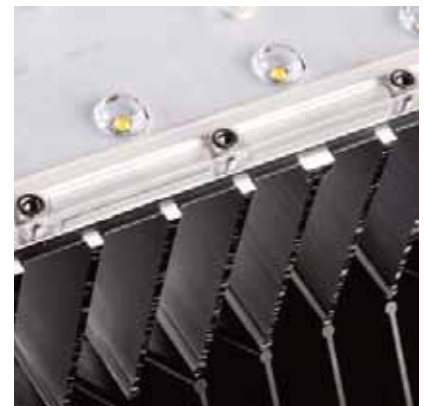

Utiliza tornillos allen inoxidable

Parameter

Especificaciones eléctricas:

Modelo.	GET-B40Zf
Potencia nominal	40W
Voltaje nominal	AC 100-240V /277V, 50/60Hz
Corriente maxima	AC 0.41A -120V, 0.21A -240V, 0.18A -277V
óptima temperatura funcionamiento:	-40 °C to +50 °C
Factor Potencia (PF)	> 0.9
Eficiencia del driver	> 90%

Especificaciones fotométricas:

Anodized aluminum	4000 lm (+/- 5%)
Eficiencia luminosa	60° 90° 110°
CRI	> 70 CRI
Color de temperatura	

Especificaciones físicas:

Nivel Protección (IP)	IP66, IK10
Vida útil	> 60,000 hours -L70(9K), @25 °C (77 °F)
Material	Aluminio anodizado
Lente	PC
Dimensiones	166 x270 x190 mm 6.5 x10.6 x7.5 inches
peso	2.4 kg /5.3 lbs